

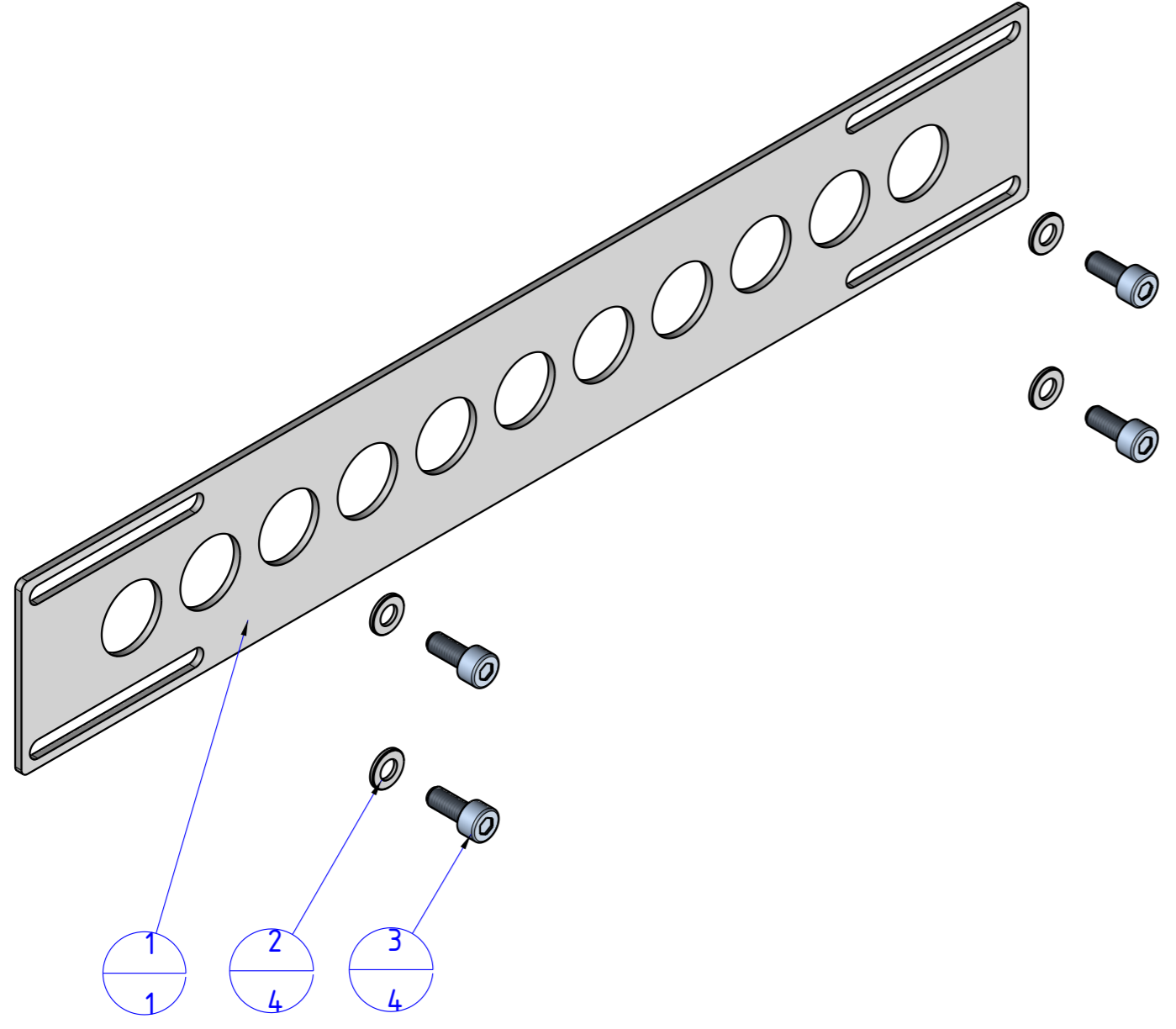

THE PROPERTY OF THE DRAWING IS ESTABLISHED BY LAW. IT IS FORBIDDEN TO PRODUCE OR SHOW IT TO THIRD PART. WITHOUT A WRITTEN AGREEMENT.

Item	Name	Q.ty
1	EPL.50.25.320	1
2	R.5	4
3	V.TCE5x12	4

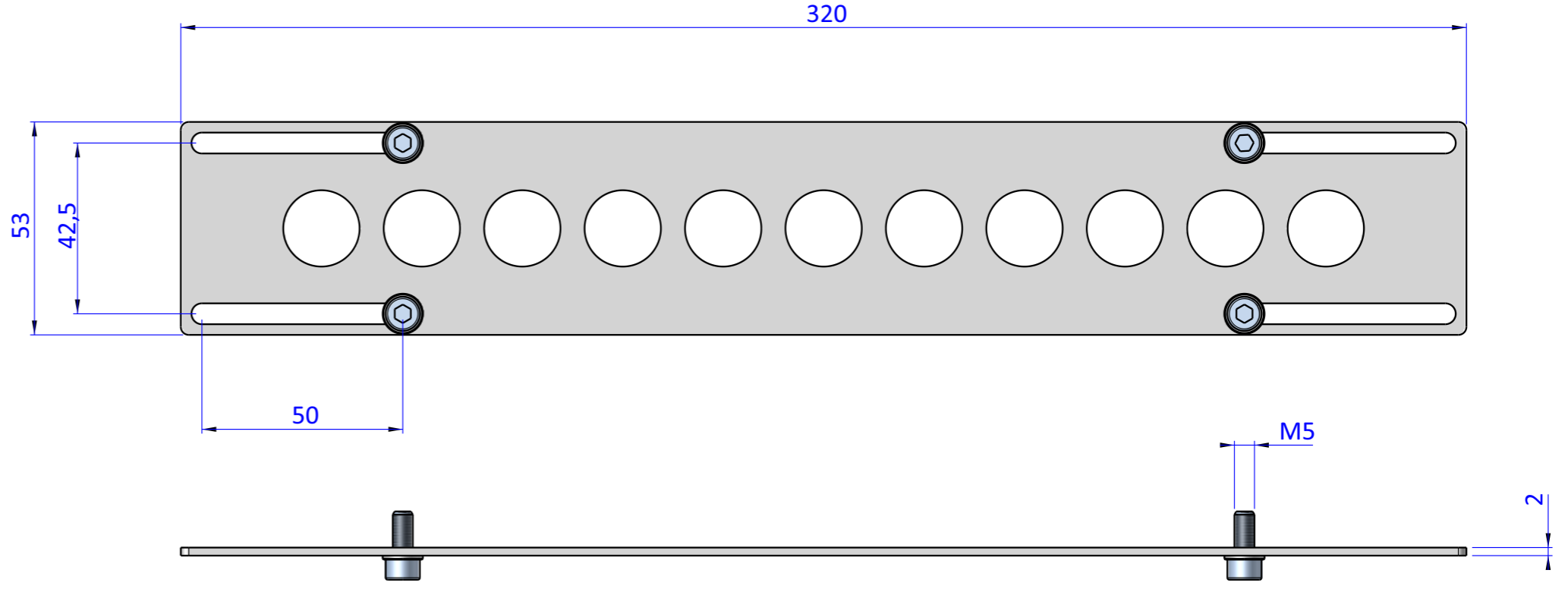

Format A3
UNI 936-76

 FPS SERVICES AUTOMATION		DESIGNED FROM FPS Automation		REVIEW A
		DATE -	WEIGHT 0,217kg	
GENERAL TOLERANCE UNI - ISO 2768 CLASSE f	DESCRIPTION CA.EPL.50.25.320		CODE CA.EPL.50.25.320	